



Z-AF050
Stapeln
Inv.-Nr 9706913

Station 1

Building a Global Battery Champion

November 2022

Disclaimer



The following presentations as well as remarks/comments and explanations in this context contain forward-looking statements on the business development of PowerCo. These statements are based on assumptions relating to the development of the economic, political and legal environment in individual countries, economic regions and markets, and in particular for the automotive industry, which we have made on the basis of the information available to us and which we consider to be realistic at the time of going to press. This also applies to statements or information given with respect to research, development and feasibility of technical concepts, targets and projects. The estimates given entail a degree of risk, and actual developments may differ from those forecast. At the time of preparing these presentations, it is not yet possible to conclusively assess the specific effects of the latest developments in the Russia-Ukraine conflict on PowerCo's business, nor is it possible to predict with sufficient certainty to what extent further escalation of the Russia-Ukraine conflict will impact on the global economy and growth in the industry in fiscal year 2022.

Any changes in significant parameters relating to our key sales markets, or any significant shifts in exchange rates, energy and other commodities or commodities relevant to PowerCo or the supply with parts, or deviations in the actual effects of the Covid-19 pandemic from the scenario presented will have a corresponding effect on the development of our business. In addition, there may be departures from our expected business development if the assessments of the factors influencing sustainable value enhancement and of risks and opportunities presented develop in a way other than we are currently expecting, or if additional risks and opportunities or other factors emerge that affect the development of our business. We do not update forward-looking statements retrospectively. Such statements are valid on the date of publication and can be superseded.

This information does not constitute an offer to exchange or sell or an offer to exchange or buy any securities.

PowerCo at a glance



PowerCo has a **large demand** pipeline from key customer Volkswagen Group

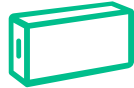

The **Unified Cell technology** allows for low complexity & standardization ...



... and a **standard factory** design, which all PowerCo gigafactories are set up to



Vertical integration allows for a secure raw material supply chain ...



... with **sustainability** as an integral part of PowerCo's DNA



VW talent pool and **engineering know-how** as important basis to scale operations



Targeting further **automotive** and **non-automotive customers**

Fully operational and highly skilled Executive Board



Frank Blome

Chief Executive Officer

Prior experience
*Continental, Li-Tech Battery,
Accumotive*



Sebastian Wolf

Chief Operating Officer

Prior experience
*Bosch, Boston Consulting Group,
Farasis*

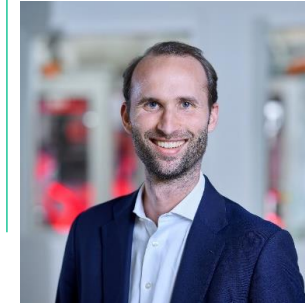

Kai Alexander Müller

Chief Financial Officer

Prior experience
Bank of America, Barclays



Soonho Ahn

Chief Technology Officer

Prior experience
LG Chem, Samsung SDI, Apple



Jörg Teichmann

Chief Purchasing Officer

Prior experience
*ZF Friedrichshafen, BMW,
Volkswagen AG*

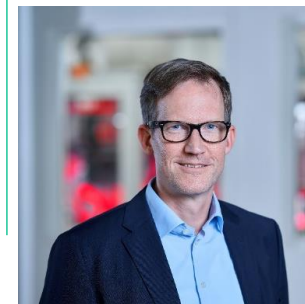

Sebastian Krapoth

Chief Human Resource Officer

Prior experience
*Volkswagen Commercial
Vehicles, Volkswagen AG*



PowerCo has already reached significant milestones:



Incorporated as **Société Européenne (SE)**



Executive Board and **Supervisory Board** in place since June 2022



Started with **350 employees on day 1**, now at >500 and growing every day



Ground breaking of lead plant in **Salzgitter** on 7th July 2022



Signed €3bn **Umicore JV** in September 2022 for cathode material production



PowerCo



Technology



Industrialization



Vertical Integration



Energy Storage Systems



Equipment



Transitioning into the EV world – significant scaling required across battery industry

Global battery demand is mainly driven by mobility

[GWh]

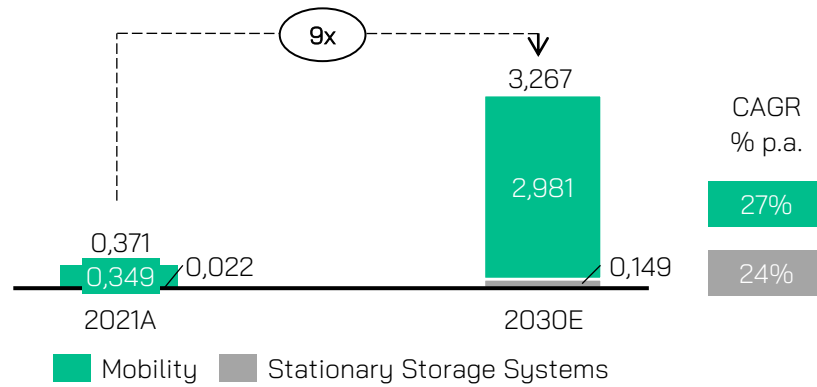

Volkswagen Group demand for PowerCo

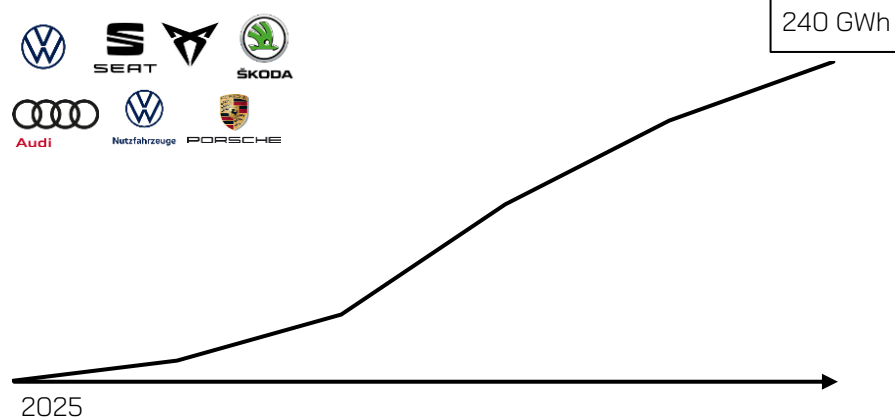

Changing the approach – the Unified Cell (UFC) allows for speed & agility



Current Approach

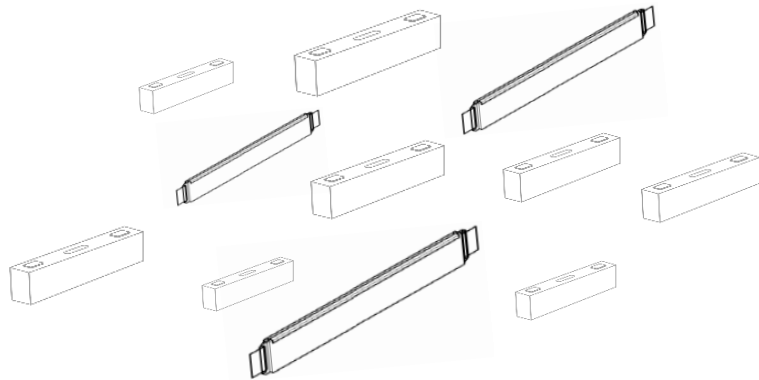

The Unified Cell

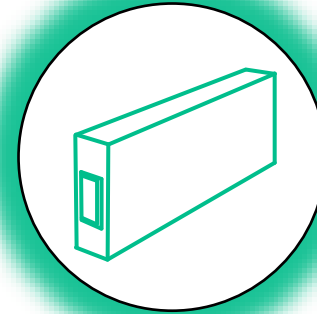

Cell format stays the same, while the chemistry inside determines the capabilities (range and charging speed)

The Unified Cell design approach ensures standardization of the battery and fits in >80% of VW Group upcoming BEVs

The Unified Cell has a standardized geometry but variable chemistry

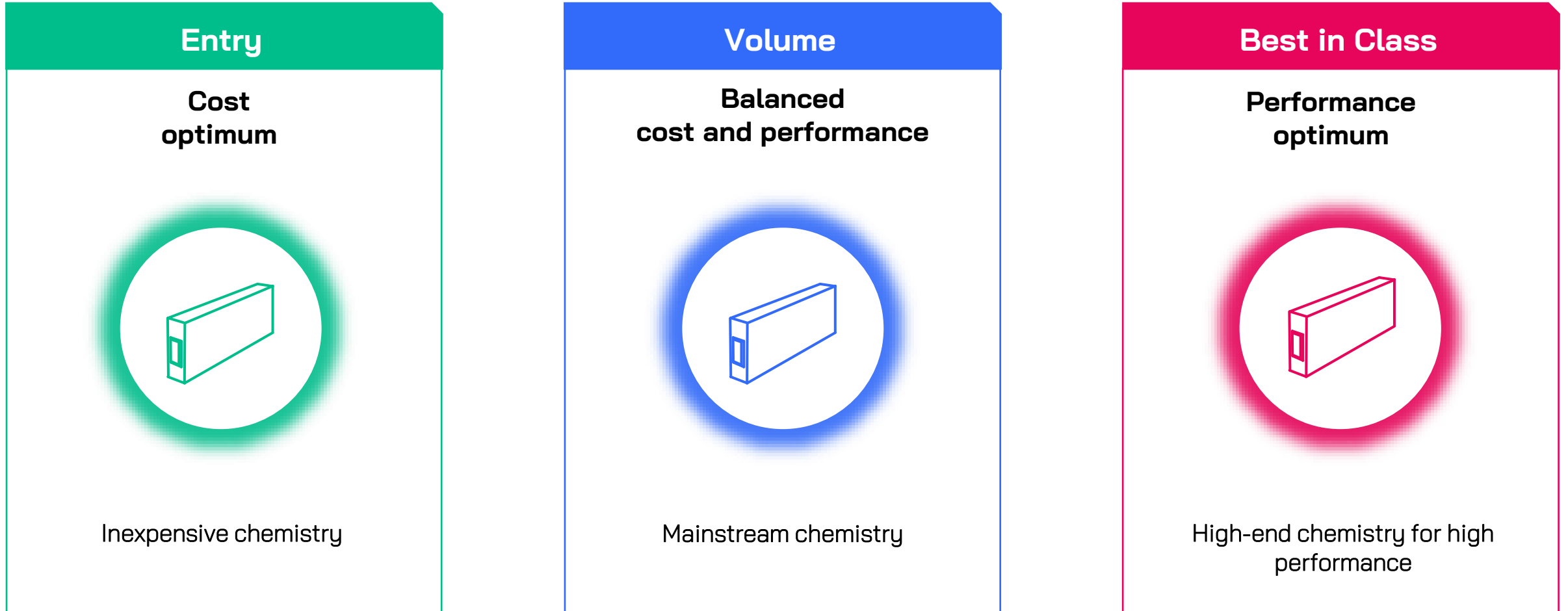

The Unified Cell has clear advantages including a significant cost benefit



The UFC's future proof standardized design, coupled with a fully standardized production system is key to take complete advantage of economies of scale



Flexibility in chemistry



High efficiency



Highest energy density



Excellent fast charge performance



Superior safety

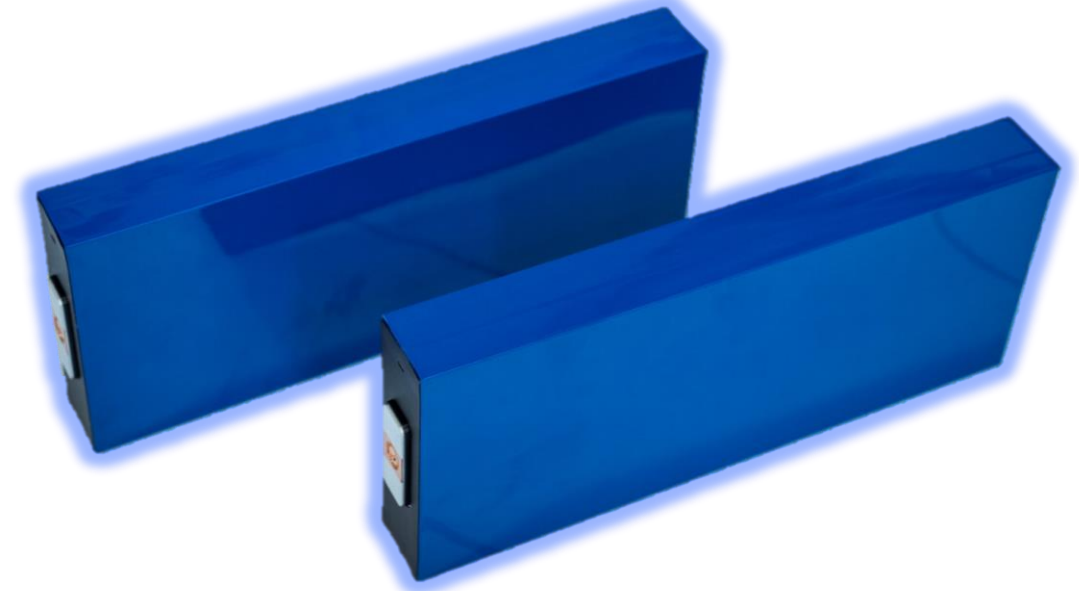

The standard factory is a key enabler for our industrialization strategy



Standard Building Column Grid

For maximum standardization and land use

Lean Line Design

Production lines follow value stream concept from mixing to filling

Flexible Production Footprint

Adaptable to different chemistries and formats

Single Story Production Area

Minimizing construction times, while maximizing flexibility



Up to **50%** launch time
reduction due to standardization

Cost reduction of **30%** per
GWh compared to benchmark

Energy consumption reduction
target of up to **30%** from
process innovations

100% green energy
sourcing target with dedicated
renewable energy support

Salzgitter is the lead plant and the blueprint for the international rollout

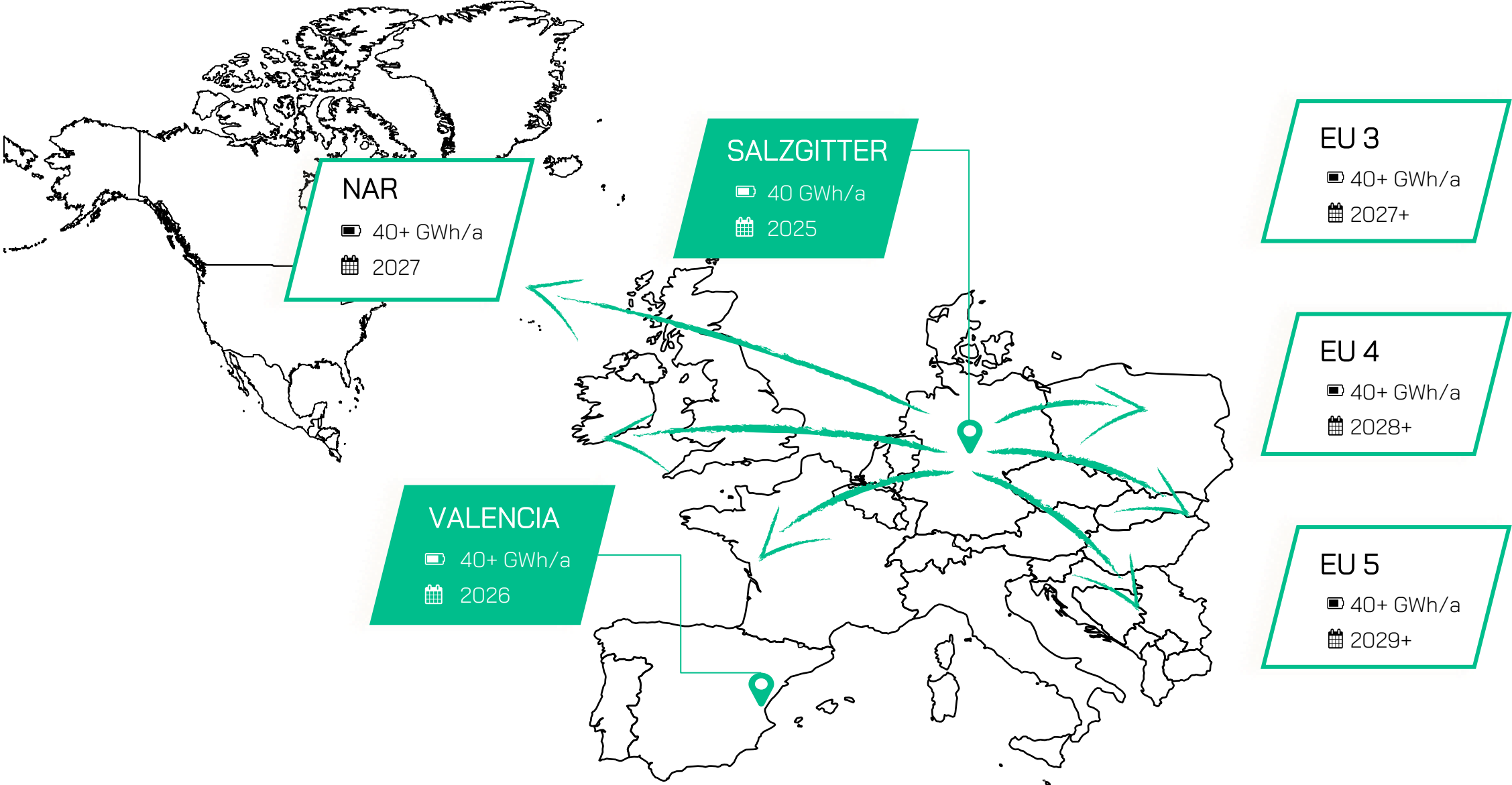

Raw material prices on a clear upward trend with near term volatility



Battery costs account for up to **40 %** of the electric vehicle's total costs



up to **70-80%** of the cell price can be materials input costs



...and up to **40%** of the cell price can just be raw materials

Raw material investments and contracts are key to secure volumes and competitive pricing ...



Battery raw materials

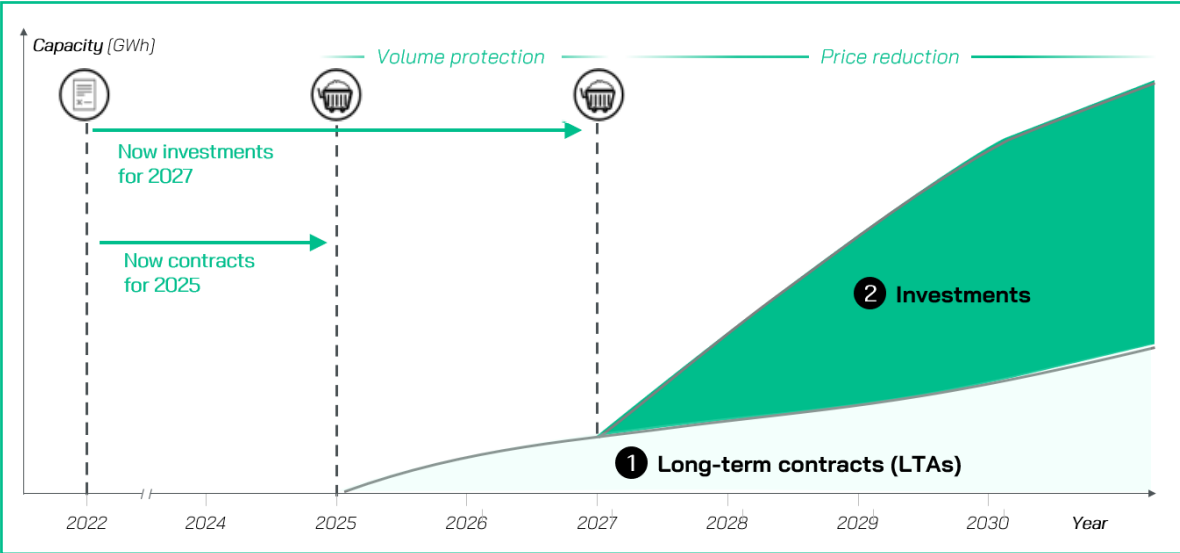

- Long-term contracts serve to secure volumes
- Participations enable more control and potentially lower input prices longer term
- Contracts and investment projects are already under discussion, with some already signed

... while cathode material processing is a key value driver within the supply chain

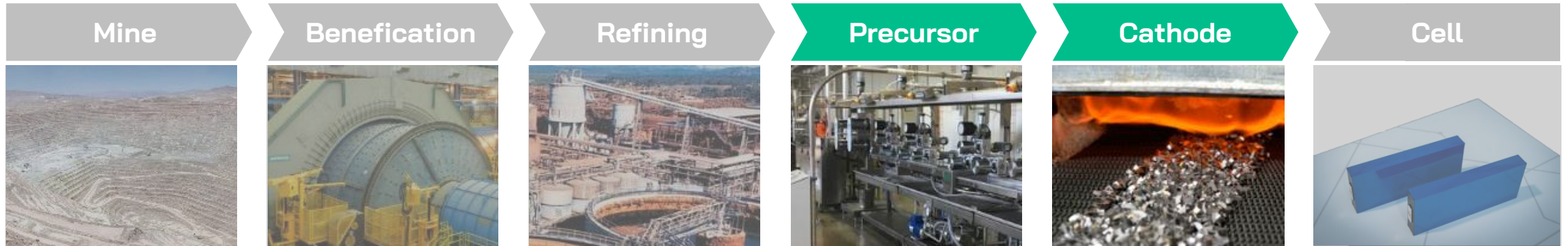

Cathode material

Joint Venture (50:50)



- Umicore is a leading materials technology and recycling group
- Signed **Joint Venture in September 2022** for precursor and cathode material production capacities in Europe → largest in the region by 2030e
- Joint venture **invests € 3 billion** to produce battery materials for 160GWh (2.2 million BEVs) per year by the end of the decade

Sustainability is an integral part of PowerCo's DNA



Vertical Integration

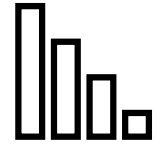

Economies of scale

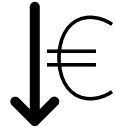

Lower costs

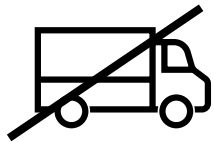

Lower reliance on suppliers



Ensure quality control

Higher degree of vertical integration provides visibility and allows to shape ESG strategy across the supply chain

Volkswagen AG is an active partner in the IRMA initiative, setting standards in the responsible procurement of raw materials

Energy Sourcing

100%

Renewable Energy*

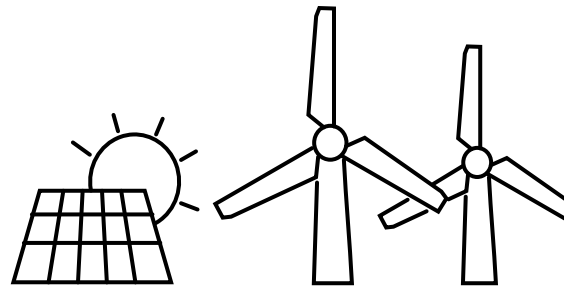

*if not available done through offsetting

Closed Loop Approach

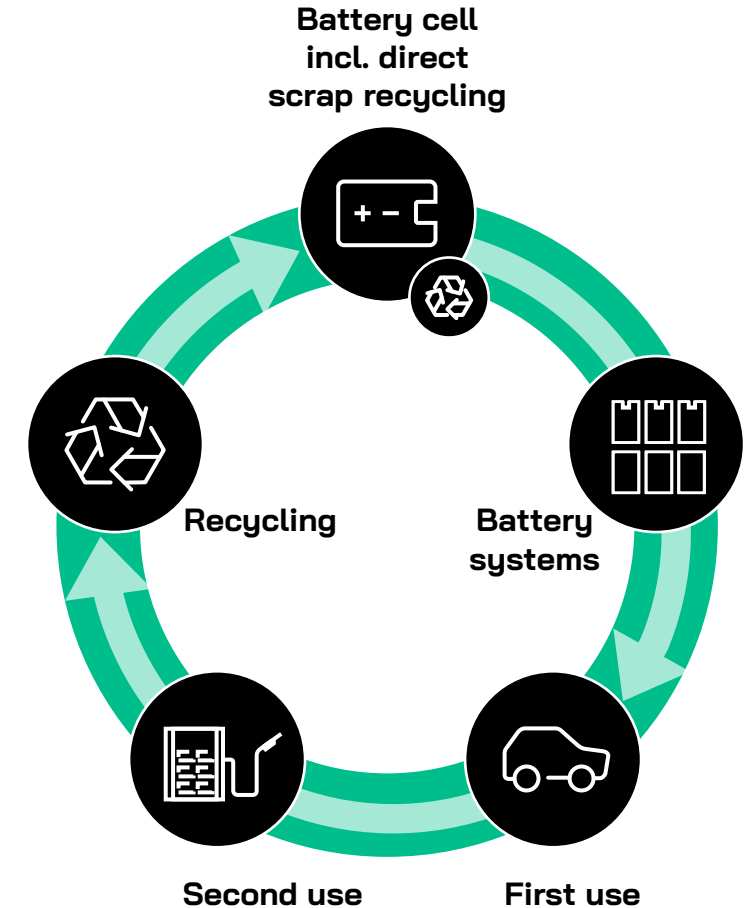

Targeting further automotive and non-automotive customers



Other OEMs

Non-Automotive Customers

...via Volkswagen's platform business

VOLKSWAGEN
AKTIENGESELLSCHAFT



Ford
Mahindra
Others...

Modular Electric Platform (MEB)
Scalable Systems Platform (SSP)

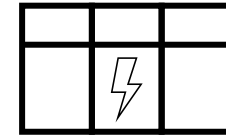

**Energy Storage
Systems**

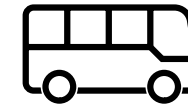

Busses



Trains

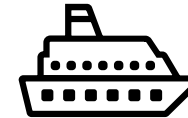

Ships



Trucks

...or directly to other OEMs using the UFC

Use case: energy storage systems

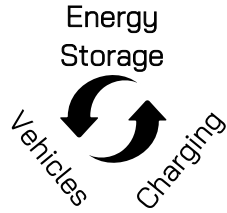

Full battery eco-system

for passenger and commercial vehicles, energy storage systems and charging



Additional volume

drive economies of scale

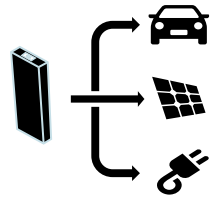

Product diversification

enables flexibility and reduces automotive cell volume dependency



Factory sustainability

and energy cost improvement potential

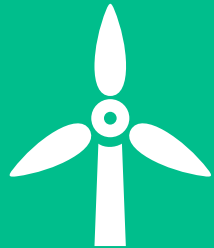

6.2 TWh

Yearly green energy lost in Germany due to lack of storage facilities



1,900,000 x

Households (yearly energy demand)



2,700,000 x

Vehicles (yearly energy demand)

PowerCo has made substantial progress since VW PowerDay in March 2021



2021

2022

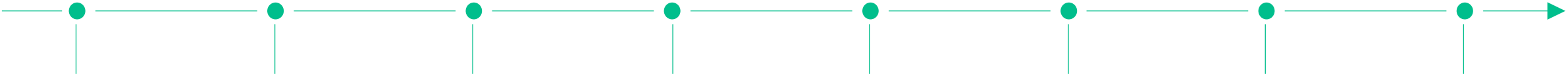

8th Dec 2021

8th Dec 2021

8th Dec 2021

6th May 2022

8th June 2022

7th July 2022

23rd Aug 2022

26th Sep 2022

Partnership with 24M

Joint development of SemiSolid™ battery cell production technology



Signing of Supply agreement with Vulcan Energy

Supply of CO₂-neutral lithium sourced in Germany



MoU Joint Venture with Umicore

European production capabilities of precursor and cathode material



Announcement of 2nd battery plant in Valencia, Spain

Construction expected to begin in Q1/2023, with production to commence in 2026



Volkswagen Group considers battery production in North America

PowerCo starts site search process to localise in the NAR region



Ground breaking for construction of battery plant in Salzgitter, Germany

Production expected to commence in 2025

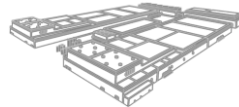

MoU with Canadian Government

To investigate opportunity for Canada to contribute to PowerCo's global and regional battery supply chains



Signing of Joint Venture with Umicore

Joint investment of €3bn to form the largest European production capacity of precursor and cathode material



Speed & Agility

through low
complexity and
standardization



PowerCo

BATTERIES. FOR GENERATIONS TO COME.

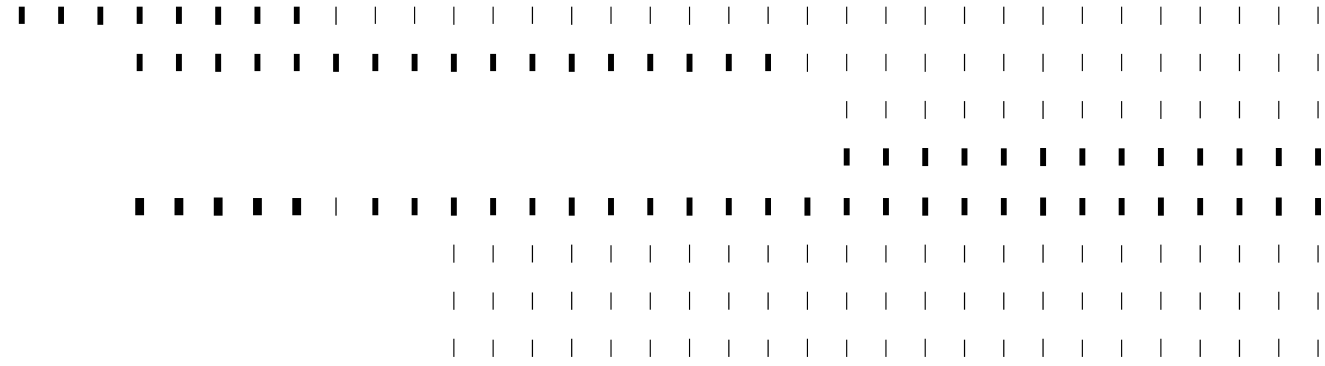
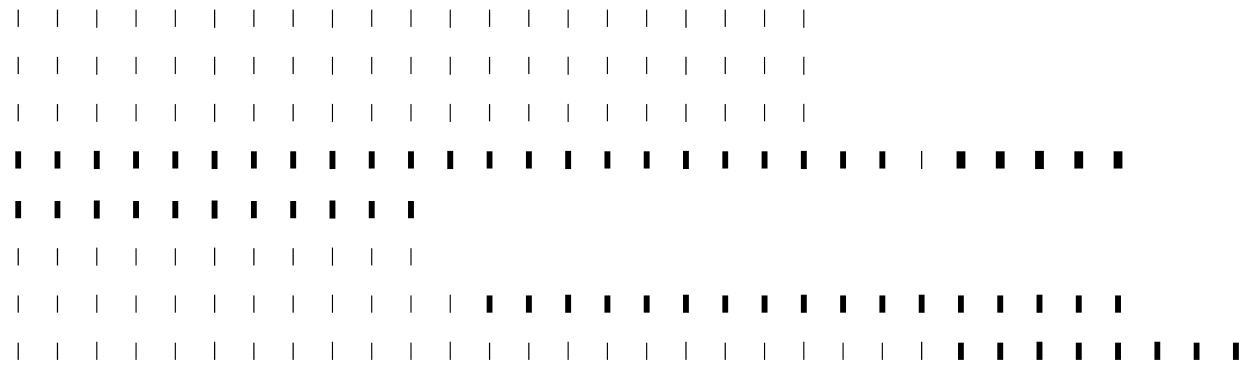

Thank You!